

TOSHIBA BIPOLAR LINEAR INTEGRATED CIRCUIT SILICON MONOLITHIC
TA78DL05AF, TA78DL06AF, TA78DL08AF, TA78DL09AF
TA78DL10AF, TA78DL12AF, TA78DL15AF

5 V, 6 V, 8 V, 9 V, 10 V, 12 V, 15 V
LOW DROPOUT VOLTAGE REGULATOR.

The TA78DLXXAF series consists of positive fixed output voltage regulator IC capable of sourcing current up to 250 mA.

Due to the features of low dropout voltage and low standby current, these devices are useful for battery powered equipment.

This series includes current limiting, thermal shutdown, overvoltage protection, input fault protection and excessive transient protection circuits internally.

FEATURES

- Low Standby Current of 500 μ A Typical.
- Maximum Output Current Up to 250 mA.
- Low Dropout Voltage of Less than 0.6 V ($I_{OUT} = 0.2$ A).
- Multi-protection
 - : Reverse Connection of Power Supply, 60 V Load Dump, Thermal Shut Down and Current Limiting.
- Packaged in POWER MOLD.

BLOCK DIAGRAM

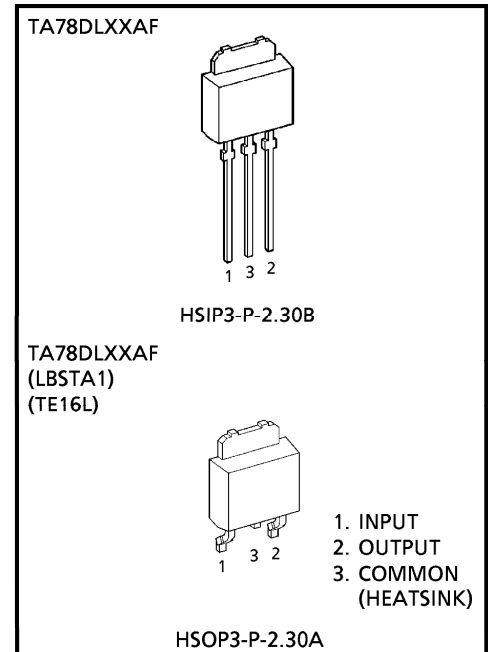
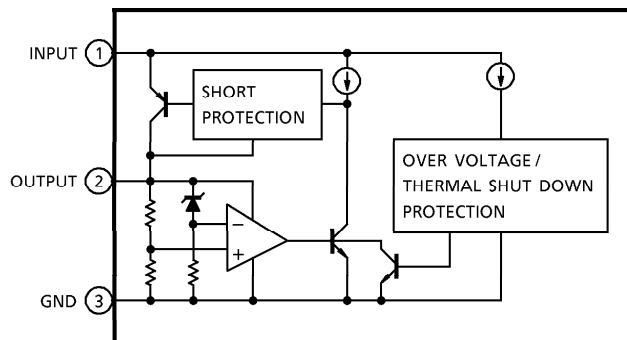

Weight
 HSIP3-P-2.30B : 0.36 g (Typ.)
 HSOP3-P-2.30A : 0.36 g (Typ.)

980910EBA1

● TOSHIBA is continually working to improve the quality and the reliability of its products. Nevertheless, semiconductor devices in general can malfunction or fail due to their inherent electrical sensitivity and vulnerability to physical stress. It is the responsibility of the buyer, when utilizing TOSHIBA products, to observe standards of safety, and to avoid situations in which a malfunction or failure of a TOSHIBA product could cause loss of human life, bodily injury or damage to property. In developing your designs, please ensure that TOSHIBA products are used within specified operating ranges as set forth in the most recent products specifications. Also, please keep in mind the precautions and conditions set forth in the TOSHIBA Semiconductor Reliability Handbook.

● The products described in this document are subject to the foreign exchange and foreign trade laws.

● The information contained herein is presented only as a guide for the applications of our products. No responsibility is assumed by TOSHIBA CORPORATION for any infringements of intellectual property or other rights of the third parties which may result from its use. No license is granted by implication or otherwise under any intellectual property or other rights of TOSHIBA CORPORATION or others.

● The information contained herein is subject to change without notice.

MAXIMUM RATINGS (Ta = 25°C)

CHARACTERISTIC	SYMBOL	RATING	UNIT
Operating Input Voltage	V _{IN}	29	V
Input Voltage of Surge	V _{IN}	60	V
Power Dissipation	(Ta = 25°C)	1	W
	(Tc = 25°C)	10	
Operating Temperature	T _{opr}	-40~85	°C
Storage Temperature	T _{stg}	-55~150	°C
Junction Temperature	T _j	150	°C
Thermal Resistance	R _{th(j-c)}	12.5	°C/W
	R _{th(j-a)}	125	
Storage Temperature-Time	T _{sol}	260 (10 s)	°C

TA78DL05AF

ELECTRICAL CHARACTERISTICS (Unless otherwise specified, V_{IN} = 14 V, I_{OUT} = 10 mA, T_j = 25°C)

CHARACTERISTIC	SYMBOL	TEST CIR-CUIT	TEST CONDITION	MIN.	TYP.	MAX.	UNIT
Output Voltage	V _{OUT}	—	5.35 V ≤ V _{IN} ≤ 26 V -40°C ≤ Ta ≤ 85°C	4.75	5	5.25	V
Line Regulation	ΔV _{OUT(1)}	—	9 V ≤ V _{IN} ≤ 16 V	—	2	10	mV
			6 V ≤ V _{IN} ≤ 26 V	—	4	30	
Load Regulation	ΔV _{OUT(2)}	—	10 mA ≤ I _{OUT} ≤ 200 mA	—	14	50	mV
Quiescent Current	I _{CC}	—	I _{OUT} ≤ 10 mA, 6 V ≤ V _{IN} ≤ 26 V	—	0.5	1	mA
Dropout Voltage	V _{DROP}	—	I _{OUT} = 50 mA	—	0.15	0.3	V
			I _{OUT} = 200 mA	—	0.4	0.6	
Max. Operating Voltage	V _{IN}	—	—	29	33	—	V

TA78DL06AF

ELECTRICAL CHARACTERISTICS (Unless otherwise specified, V_{IN} = 14 V, I_{OUT} = 10 mA, T_j = 25°C)

CHARACTERISTIC	SYMBOL	TEST CIR-CUIT	TEST CONDITION	MIN.	TYP.	MAX.	UNIT
Output Voltage	V _{OUT}	—	6.35 V ≤ V _{IN} ≤ 26 V -40°C ≤ Ta ≤ 85°C	5.7	6	6.3	V
Line Regulation	ΔV _{OUT(1)}	—	10 V ≤ V _{IN} ≤ 17 V	—	2	12	mV
			7 V ≤ V _{IN} ≤ 26 V	—	5	36	
Load Regulation	ΔV _{OUT(2)}	—	10 mA ≤ I _{OUT} ≤ 200 mA	—	17	60	mV
Quiescent Current	I _{CC}	—	I _{OUT} ≤ 10 mA, 7 V ≤ V _{IN} ≤ 26 V	—	0.55	—	mA
Dropout Voltage	V _{DROP}	—	I _{OUT} = 50 mA	—	0.15	0.3	V
			I _{OUT} = 200 mA	—	0.4	0.6	
Max. Operating Voltage	V _{IN}	—	—	29	33	—	V

TA78DL08AF

ELECTRICAL CHARACTERISTICS (Unless otherwise specified, $V_{IN} = 16\text{ V}$, $I_{OUT} = 10\text{ mA}$, $T_j = 25^\circ\text{C}$)

CHARACTERISTIC	SYMBOL	TEST CIR-CUIT	TEST CONDITION	MIN.	TYP.	MAX.	UNIT
Output Voltage	V_{OUT}	—	$8.35\text{ V} \leq V_{IN} \leq 26\text{ V}$ $-40^\circ\text{C} \leq T_a \leq 85^\circ\text{C}$	7.6	8	8.4	V
Line Regulation	$\Delta V_{OUT(1)}$	—	$12\text{ V} \leq V_{IN} \leq 19\text{ V}$	—	3	16	mV
			$9\text{ V} \leq V_{IN} \leq 26\text{ V}$	—	6	45	
Load Regulation	$\Delta V_{OUT(2)}$	—	$10\text{ mA} \leq I_{OUT} \leq 200\text{ mA}$	—	22	80	mV
Quiescent Current	I_{CC}	—	$I_{OUT} \leq 10\text{ mA}$, $9\text{ V} \leq V_{IN} \leq 26\text{ V}$	—	0.6	—	mA
Dropout Voltage	V_{DROP}	—	$I_{OUT} = 50\text{ mA}$	—	0.15	0.3	V
			$I_{OUT} = 200\text{ mA}$	—	0.4	0.6	
Max. Operating Voltage	V_{IN}	—	—	29	33	—	V

TA78DL09AF

ELECTRICAL CHARACTERISTICS (Unless otherwise specified, $V_{IN} = 16\text{ V}$, $I_{OUT} = 10\text{ mA}$, $T_j = 25^\circ\text{C}$)

CHARACTERISTIC	SYMBOL	TEST CIR-CUIT	TEST CONDITION	MIN.	TYP.	MAX.	UNIT
Output Voltage	V_{OUT}	—	$9.35\text{ V} \leq V_{IN} \leq 26\text{ V}$ $-40^\circ\text{C} \leq T_a \leq 85^\circ\text{C}$	8.55	9	9.45	V
Line Regulation	$\Delta V_{OUT(1)}$	—	$13\text{ V} \leq V_{IN} \leq 20\text{ V}$	—	3	18	mV
			$10\text{ V} \leq V_{IN} \leq 26\text{ V}$	—	7	50	
Load Regulation	$\Delta V_{OUT(2)}$	—	$10\text{ mA} \leq I_{OUT} \leq 200\text{ mA}$	—	25	90	mV
Quiescent Current	I_{CC}	—	$I_{OUT} \leq 10\text{ mA}$, $10\text{ V} \leq V_{IN} \leq 26\text{ V}$	—	0.65	—	mA
Dropout Voltage	V_{DROP}	—	$I_{OUT} = 50\text{ mA}$	—	0.15	0.3	V
			$I_{OUT} = 200\text{ mA}$	—	0.4	0.6	
Max. Operating Voltage	V_{IN}	—	—	29	33	—	V

TA78DL10AF

ELECTRICAL CHARACTERISTICS (Unless otherwise specified, $V_{IN} = 16\text{ V}$, $I_{OUT} = 10\text{ mA}$, $T_j = 25^\circ\text{C}$)

CHARACTERISTIC	SYMBOL	TEST CIR-CUIT	TEST CONDITION	MIN.	TYP.	MAX.	UNIT
Output Voltage	V_{OUT}	—	$10.35\text{ V} \leq V_{IN} \leq 26\text{ V}$ $-40^\circ\text{C} \leq T_a \leq 85^\circ\text{C}$	9.5	10	10.5	V
Line Regulation	$\Delta V_{OUT(1)}$	—	$14\text{ V} \leq V_{IN} \leq 21\text{ V}$	—	4	20	mV
			$11\text{ V} \leq V_{IN} \leq 26\text{ V}$	—	8	60	
Load Regulation	$\Delta V_{OUT(2)}$	—	$10\text{ mA} \leq I_{OUT} \leq 200\text{ mA}$	—	28	100	mV
Quiescent Current	I_{CC}	—	$I_{OUT} \leq 10\text{ mA}$, $11\text{ V} \leq V_{IN} \leq 26\text{ V}$	—	0.7	—	mA
Dropout Voltage	V_{DROP}	—	$I_{OUT} = 50\text{ mA}$	—	0.15	0.3	V
			$I_{OUT} = 200\text{ mA}$	—	0.4	0.6	
Max. Operating Voltage	V_{IN}	—	—	29	33	—	V

TA78DL12AF

ELECTRICAL CHARACTERISTICS (Unless otherwise specified, $V_{IN} = 18\text{ V}$, $I_{OUT} = 10\text{ mA}$, $T_j = 25^\circ\text{C}$)

CHARACTERISTIC	SYMBOL	TEST CIR-CUIT	TEST CONDITION	MIN.	TYP.	MAX.	UNIT
Output Voltage	V_{OUT}	—	$12.35\text{ V} \leq V_{IN} \leq 26\text{ V}$ $-40^\circ\text{C} \leq T_a \leq 85^\circ\text{C}$	11.4	12	12.6	V
Line Regulation	$\Delta V_{OUT(1)}$	—	$16\text{ V} \leq V_{IN} \leq 23\text{ V}$	—	5	24	mV
			$13\text{ V} \leq V_{IN} \leq 26\text{ V}$	—	10	70	
Load Regulation	$\Delta V_{OUT(2)}$	—	$10\text{ mA} \leq I_{OUT} \leq 200\text{ mA}$	—	33	120	mV
Quiescent Current	I_{CC}	—	$I_{OUT} \leq 10\text{ mA}$, $13\text{ V} \leq V_{IN} \leq 26\text{ V}$	—	0.8	—	mA
Dropout Voltage	V_{DROP}	—	$I_{OUT} = 50\text{ mA}$	—	0.15	0.3	V
			$I_{OUT} = 200\text{ mA}$	—	0.4	0.6	
Max. Operating Voltage	V_{IN}	—	—	29	33	—	V

TA78DL15AF

ELECTRICAL CHARACTERISTICS (Unless otherwise specified, $V_{IN} = 20\text{ V}$, $I_{OUT} = 10\text{ mA}$, $T_j = 25^\circ\text{C}$)

CHARACTERISTIC	SYMBOL	TEST CIR-CUIT	TEST CONDITION	MIN.	TYP.	MAX.	UNIT
Output Voltage	V_{OUT}	—	$15.35\text{ V} \leq V_{IN} \leq 26\text{ V}$ $-40^\circ\text{C} \leq T_a \leq 85^\circ\text{C}$	14.25	15	15.75	V
Line Regulation	$\Delta V_{OUT(1)}$	—	$19\text{ V} \leq V_{IN} \leq 26\text{ V}$	—	6	30	mV
			$16\text{ V} \leq V_{IN} \leq 26\text{ V}$	—	12	80	
Load Regulation	$\Delta V_{OUT(2)}$	—	$10\text{ mA} \leq I_{OUT} \leq 200\text{ mA}$	—	40	150	mV
Quiescent Current	I_{CC}	—	$I_{OUT} \leq 10\text{ mA}$, $16\text{ V} \leq V_{IN} \leq 26\text{ V}$	—	0.9	—	mA
Dropout Voltage	V_{DROP}	—	$I_{OUT} = 50\text{ mA}$	—	0.15	0.3	V
			$I_{OUT} = 200\text{ mA}$	—	0.4	0.6	
Max. Operating Voltage	V_{IN}	—	—	29	33	—	V

APPLICATION CIRCUITS

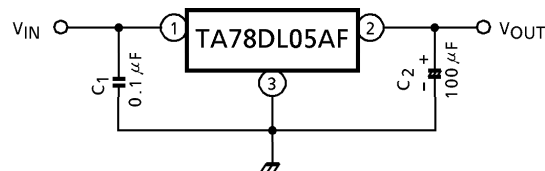

Capacitor C_2 must be guaranteed to operate of the temperature range that the regulator should be operated correctly.

$100\ \mu\text{F}$ is a suitable value to suppress the oscillation phenomenon at the output terminal.

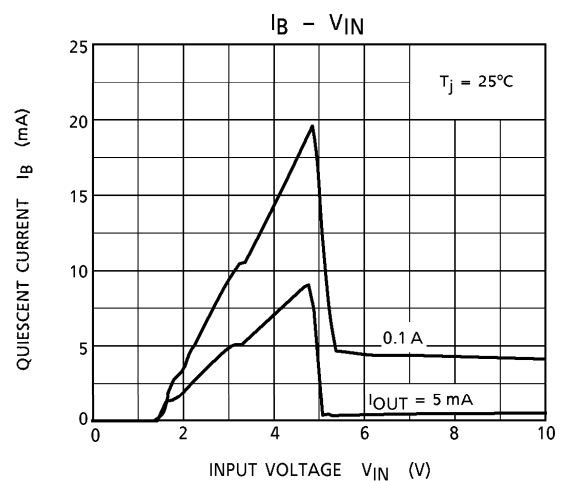
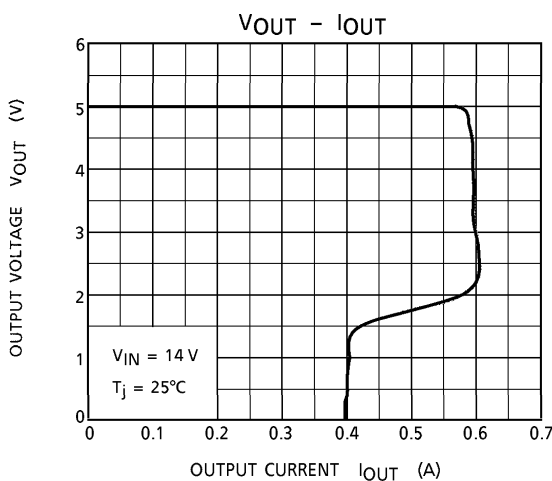
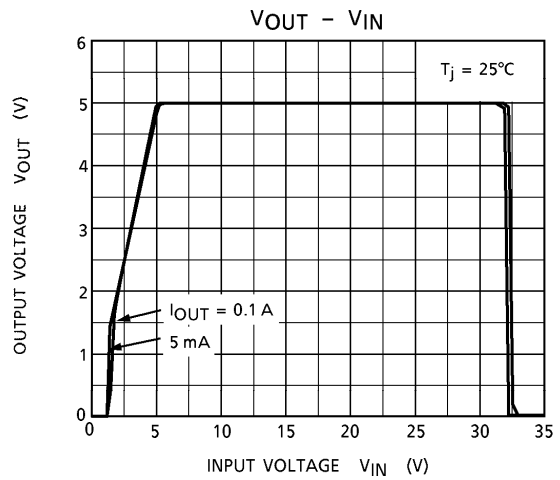
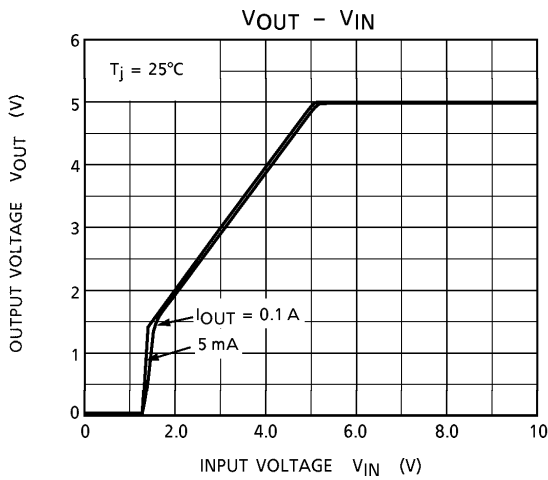
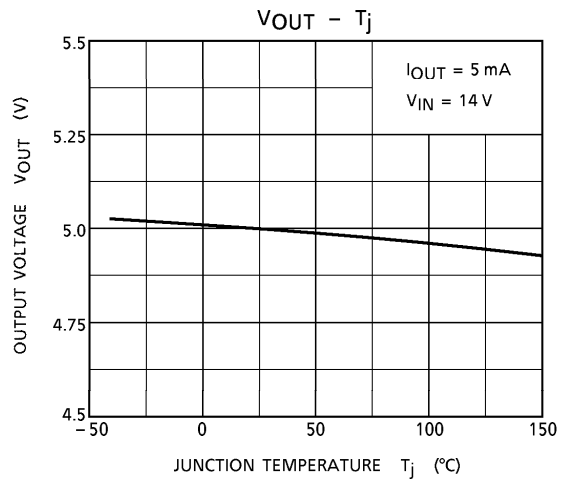
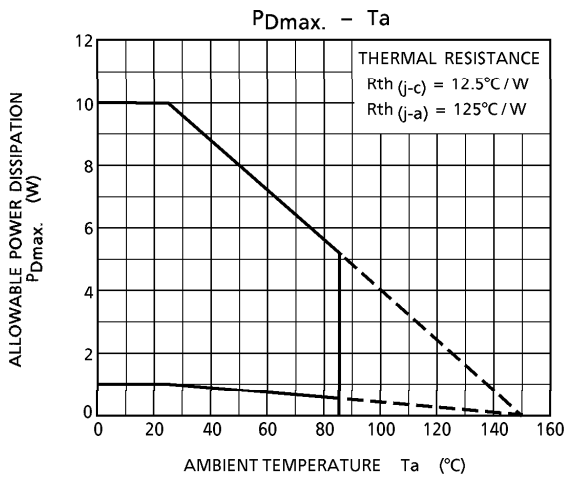

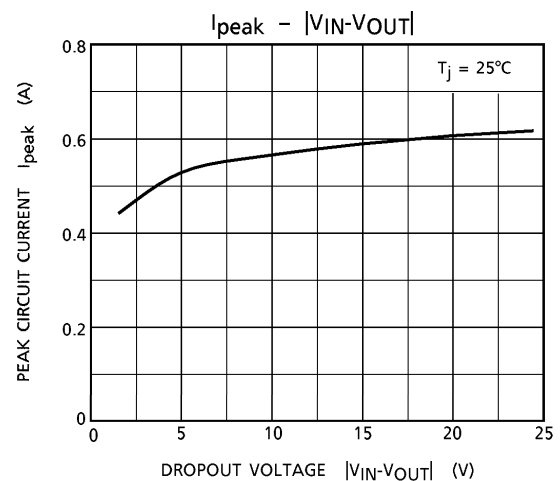
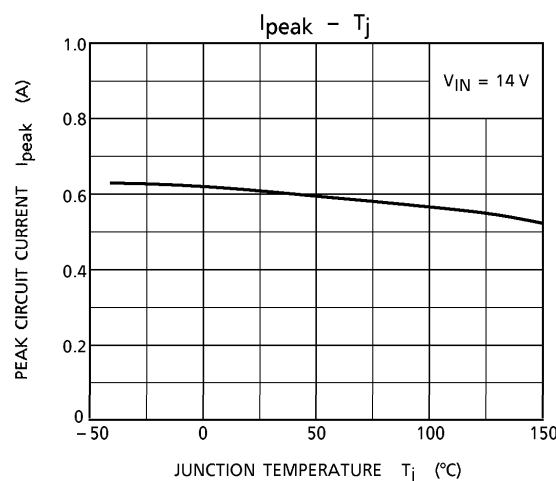
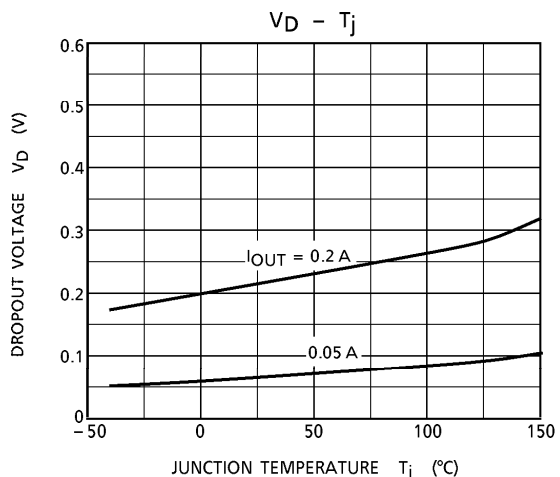
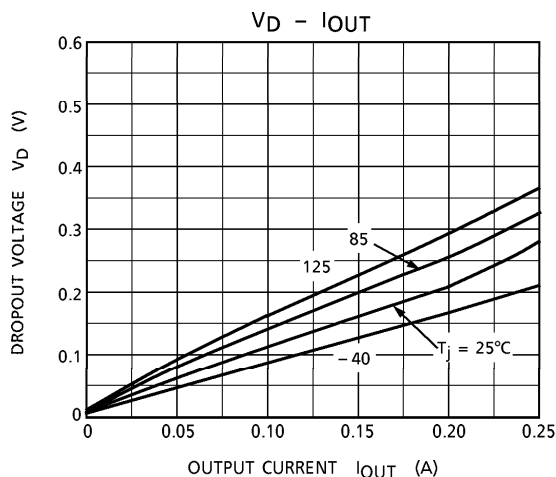
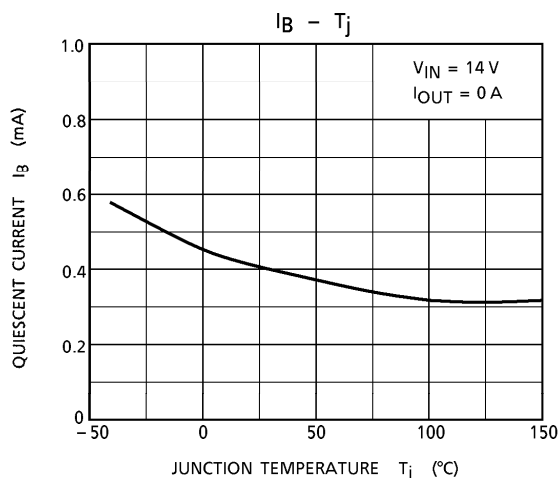
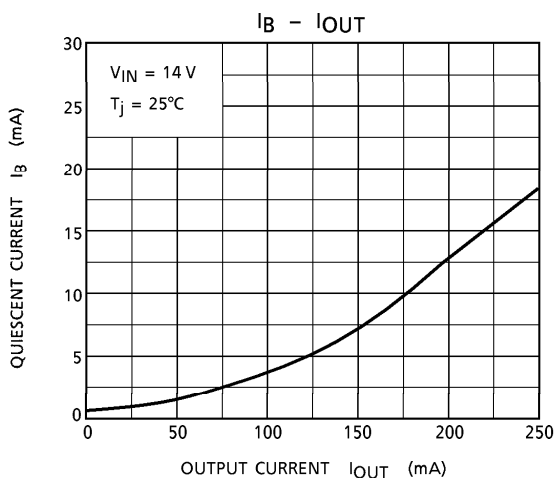

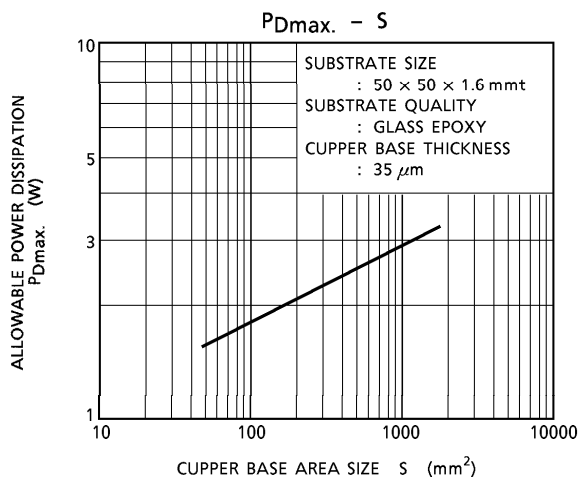

OUTLINE DRAWING
HSIP3-P-2.30B

Unit : mm

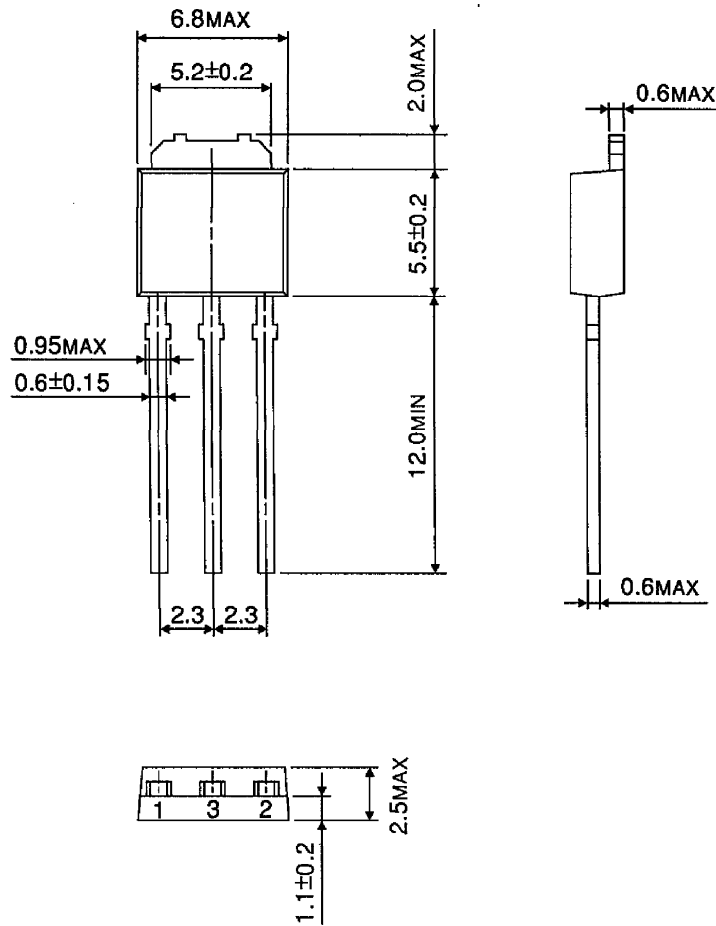

Weight : 0.36 g (Typ.)

OUTLINE DRAWING
HSOP3-P-2.30A

Unit : mm

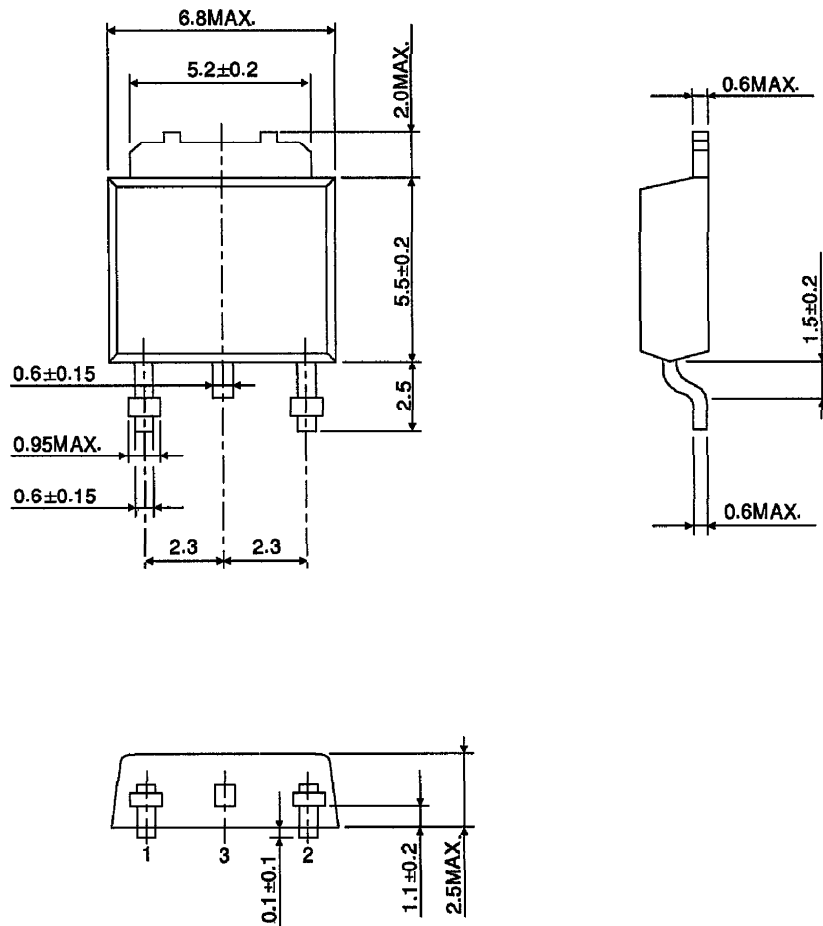

Weight : 0.36 g (Typ.)